



Heimgard

In-wall dimmer 2-pole

Quick start guide
version 1.0

Requires a
Heimgard hub

What is in the box

A.
In-wall dimmer 2-pole

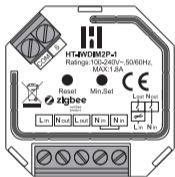

Device overview

B.
Join/
Reset
button

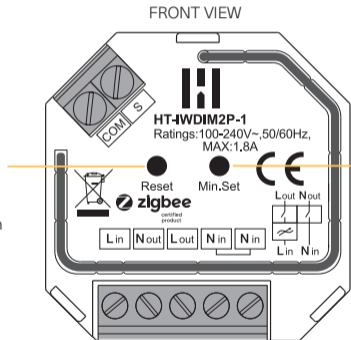

C.
Min.Set
button

Connection diagram overview

Notes for the diagrams:

L in - Live lead input terminal

N in - Neutral lead input terminal

L out - Live lead output terminal

N out - Neutral lead output terminal

S1 - External switch terminal

COM - Terminal for grounding to the switch connected to the dimmer

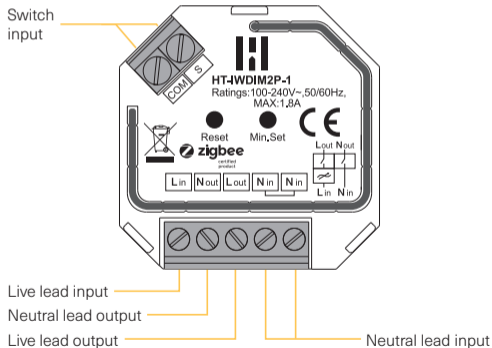

Installation and wiring

Electronical properties

- Load (A) 1.8 Max
- Voltage type AC
- Voltage (V) 100-240
- Power source AC

This device should be installed by a licensed electrician in a manner that conforms to local regulations and building codes.

WARNING: Electrical power must be switched off during installation

FIRST ENSURE THE POWER IS OFF at the main circuit breaker, and then test the wires with a probe or multimeter to verify.

Connect the input power and output wires to the correct device terminals. Follow the connection diagram and instructions on the next page.

Wiring diagram

For installation follow the wire diagrams.

Option 1: Without a connected push switch

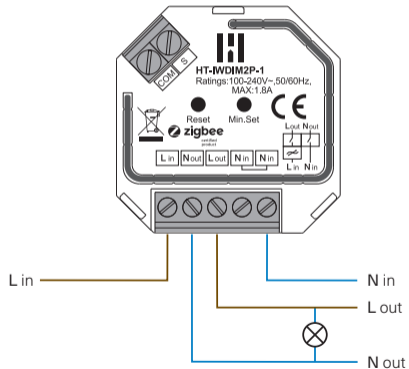

Option 2: With a connected push switch LV

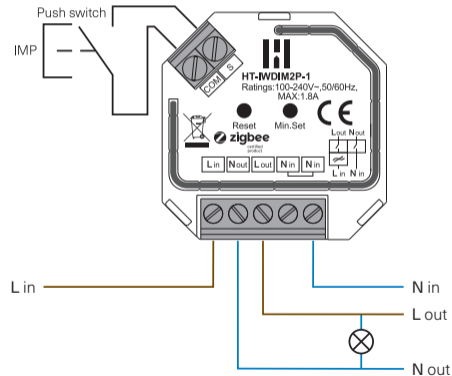

Option 3: With a connected push switch

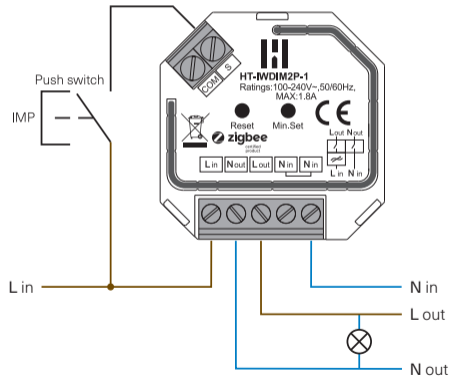

Startup brightness

This is how bright your lights are when you turn your lights on.

1. Adjust the brightness of your lights to the desired level between 1% - 50%.
2. Double Click the **Min. Set** button on the dimmer to set the brightness.
3. To delete the startup brightness value set the light brightness to minimum brightness (0%) and double-click the **Min. Set** button.

Minimum brightness

This sets the minimum brightness level on your dimmer.

1. Adjust the brightness of your lights to the desired minimum brightness.
2. Press and Hold the **Min. Set** button for 3 seconds or until connected light flashes to set the brightness value.
3. To delete the minimum brightness value set the light brightness to maximum brightness (100%) and press and hold down the **Min. Set** button until connected light flashes.

Connecting to the Hub

These steps are to be followed after the dimmer has been properly installed and wired by a certified electrician.

1. At the circuit breaker, turn off the power to the dimmer.

2. Open the **Heimgard app** and follow the steps listed here to connect to your device

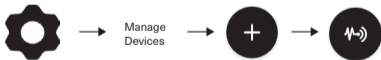

3. Turn the circuit breaker power on to power up your dimmer.

It will automatically enter pairing mode. The connected light will flash 2 times to indicate powering on.

4. When the connected light flashes 5 times and then remains on, the device has been found in your app.

5. You will now see the In-wall dimmer in your new devices. Configure the dimmer by giving it a name and adding it to a room.

Your light is now able to be controlled by your app.

Factory Reset

If your dimmer has previously been connected to a different Hub, you may need to perform a factory reset.

1. Quickly press the reset button (B) 5 times continuously.

If you do not have access to the reset button, turn the power supply on and off 5 times. This could be done either from the circuit breaker in the fuse box or from the connected wired wall switch.



2.





The device that is connected to this dimmer will turn on/off 3 times to indicate successful reset.

You will have to reconfigure your device.

Note: make sure your connected device is functioning properly.

Technical specifications

Compatible Load Type

Load Symbol	Load Type	Maximum Load	Remarks
	Dimmable LED lamps	200W @ 230V 100W @ 110V	Due to variety of LED lamp designs, maximum number of LED lamps is further dependent on power factor result when connected to dimmer
	LED drivers	200W @ 230V 100W @ 110V	Maximum permitted number of drivers is 200W divided by driver nameplate power rating
	Incandescent lighting, HV Halogen lamps	400W @ 230V 200W @ 110V	
	Low voltage halogen lighting with electronic transformers	200W @ 230V 100W @ 110V	

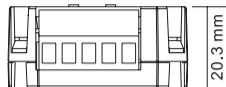
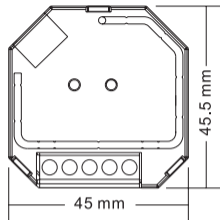

Need help?

Website:	heimgard.com/support
Email:	support@heimgard.com
Facebook:	facebook.com/heimgardnorge/
Telephone:	+47 649 44 422

Visit heimgard.com for more information and tips on how to use.

Important safety information

1. Read through these instructions and follow accordingly.
2. Clean only with dry soft cloth. Household cleaners and solvents can damage the finish on your device.
3. Do not install too close to any heat sources such as radiators, heat registers, stoves or other device that produce heat.
4. Do not use this device near water.
5. Warning: To reduce the risk of fire or electric shock, do not expose this device to rain or moisture.
6. Do not expose device to dripping or splashing.
7. Protect the attached cables from being walked on or pinched, particularly at plugs, convenience receptacles, and the point the exit the apparatus.
8. Only use attachments/accessories specified by the manufacturer.
9. All servicing should be performed by qualified service personnel. Servicing is required when the device has been damaged in any way.
10. Operating temperature: -10°C to +50°C
11. Operating relative humidity: < 95% RH (no condensation)



Dispose the product properly at the end of life. This is electronic waste which should be recycled accordingly.



Heimgard

 heimgard.com