



Heimgard

In-wall switch 16A

Quick start guide
version 1.0

Requires a
Heimgard hub

What is in the box

A.
In-wall switch 16A

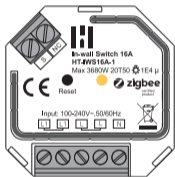

Device overview

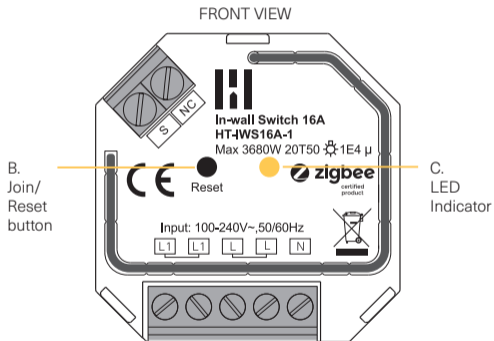

Connection diagram overview

Notes for the diagrams:

L1 - Load output terminals
(controlling connected device)
L - Live lead terminal

N - Neutral lead terminal
S - External switch terminal
NC - No Connection
GND - Grounding

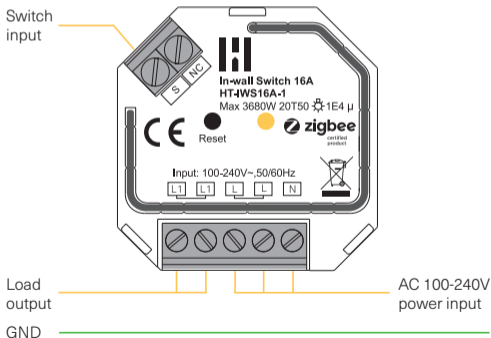

Installation and wiring

Electronical properties

- Load (A) 16 Max
- Voltage type AC
- Voltage (V) 100-240
- Power source AC

This device should be installed by a licensed electrician in a manner that conforms to local regulations and building codes.

WARNING: Electrical power must be switched off during installation

FIRST ENSURE THE POWER IS OFF at the main circuit breaker, and then test the wires with a probe or multimeter to verify.

Connect the input power and output wires to the correct device terminals. Follow the connection diagram and instructions on the next page.

Wiring diagram

For installation follow the wire diagrams.

Option 1: without a connected switch

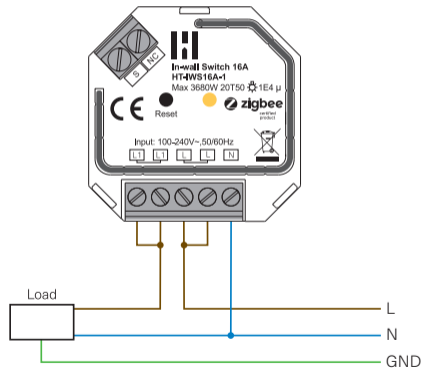

Option 2: with a connected switch

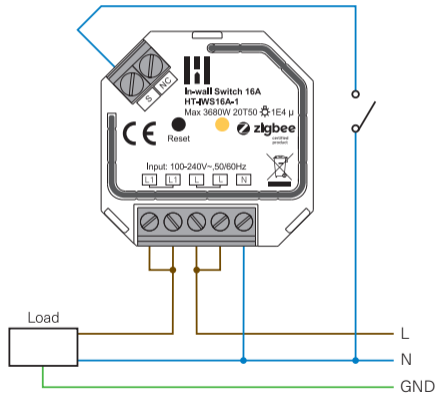

Connecting to the Hub

These steps are to be followed after the switch has been properly installed and wired by a certified electrician.

1. At the circuit breaker, turn off the power to the switch.

2. Open the **Heimgard app** and follow the steps listed here to connect to your device



3. Turn the circuit breaker power on to your switch. It will automatically enter pairing mode.

The LED indicator light on the switch will flash 2 times slowly to indicate pairing.

4. When the LED indicator flashes 5 times and then remains on the device has been found in your app.

5. You will now see the In-wall switch in your new devices list. Configure the switch by giving it a name and adding it to a room.

Your device is able to be controlled in your Heimgard app or locally with a wireless or wired switch.

Factory Reset

If your switch has previously been connected to a different Hub, you may need to perform a factory reset.

1. Quickly press the reset button (B) 5 times continuously.

If you do not have access to the reset button, turn the power supply on and off 5 times. This could be done either from the circuit breaker in the fuse box or from the connected wired wall switch.



2.





The device that is connected to this switch will turn on/off 3 times to indicate successful reset.

You will have to reconfigure your device.

Note: make sure your connected device is functioning properly.

Technical specifications

Compatible Load Type

Load Symbol	Load Type	Maximum Load	Remarks
	LED lamps with transformers	1220W @ 230V 580W @ 110V	Due to variety of LED lamp designs, maximum number of LED lamps is further dependent on power factor result when connected to switch
	LED drivers	1220W @ 230V 580W @ 110V	Maximum permitted number of drivers is 1220W divided by driver nameplate power rating
	Incandescent lighting, HV Halogen lamps	3680W @ 230V 1760W @ 110V	
	Low voltage halogen lighting with electronic transformers	1220W @ 230V 580W @ 110V	
	Electrical appliances such as television, refrigerator, water heating etc.	3680W @ 230V 1760W @ 110V	

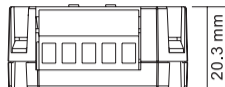
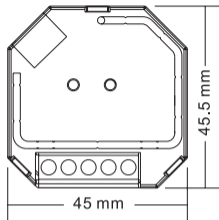

Over Current Protection

When the load current is over 16.1A for over 10 seconds, the relay will be forced to turn off and thereby protected.

When the load power is over 3700W for over 5 seconds, the relay will be forced to turn off and thereby protected.

Need help?

Website:	heimgard.com/support
Email:	support@heimgard.com
Facebook:	facebook.com/heimgardnorge/
Telephone:	+47 649 44 422

Visit heimgard.com for more information and tips on how to use.

Important safety information

1. Read through these instructions and follow accordingly.
2. Clean only with dry soft cloth. Household cleaners and solvents can damage the finish on your device.
3. Do not install too close to any heat sources such as radiators, heat registers, stoves or other device that produce heat.
4. Do not use this device near water.
5. Warning: To reduce the risk of fire or electric shock, do not expose this device to rain or moisture.
6. Do not expose device to dripping or splashing.
7. Protect the attached cables from being walked on or pinched, particularly at plugs, convenience receptacles, and the point the exit the apparatus.
8. Only use attachments/accessories specified by the manufacturer.
9. All servicing should be performed by qualified service personnel. Servicing is required when the device has been damaged in any way.
10. Operating temperature: -10°C to +50°C
11. Operating relative humidity: < 95% RH (no condensation)



Dispose the product properly at the end of life. This is electronic waste which should be recycled accordingly.



Heimgard

 heimgard.com